

LockerWall

BISLEY

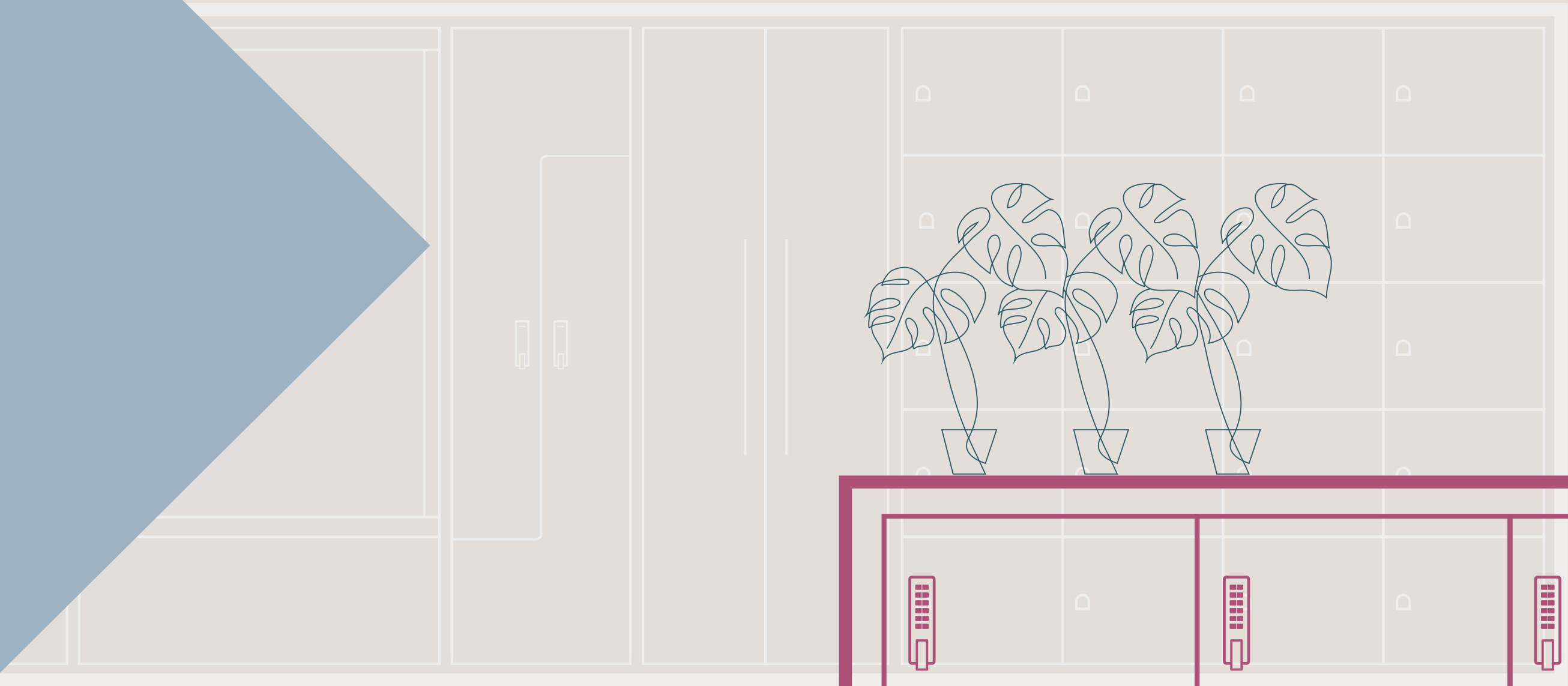
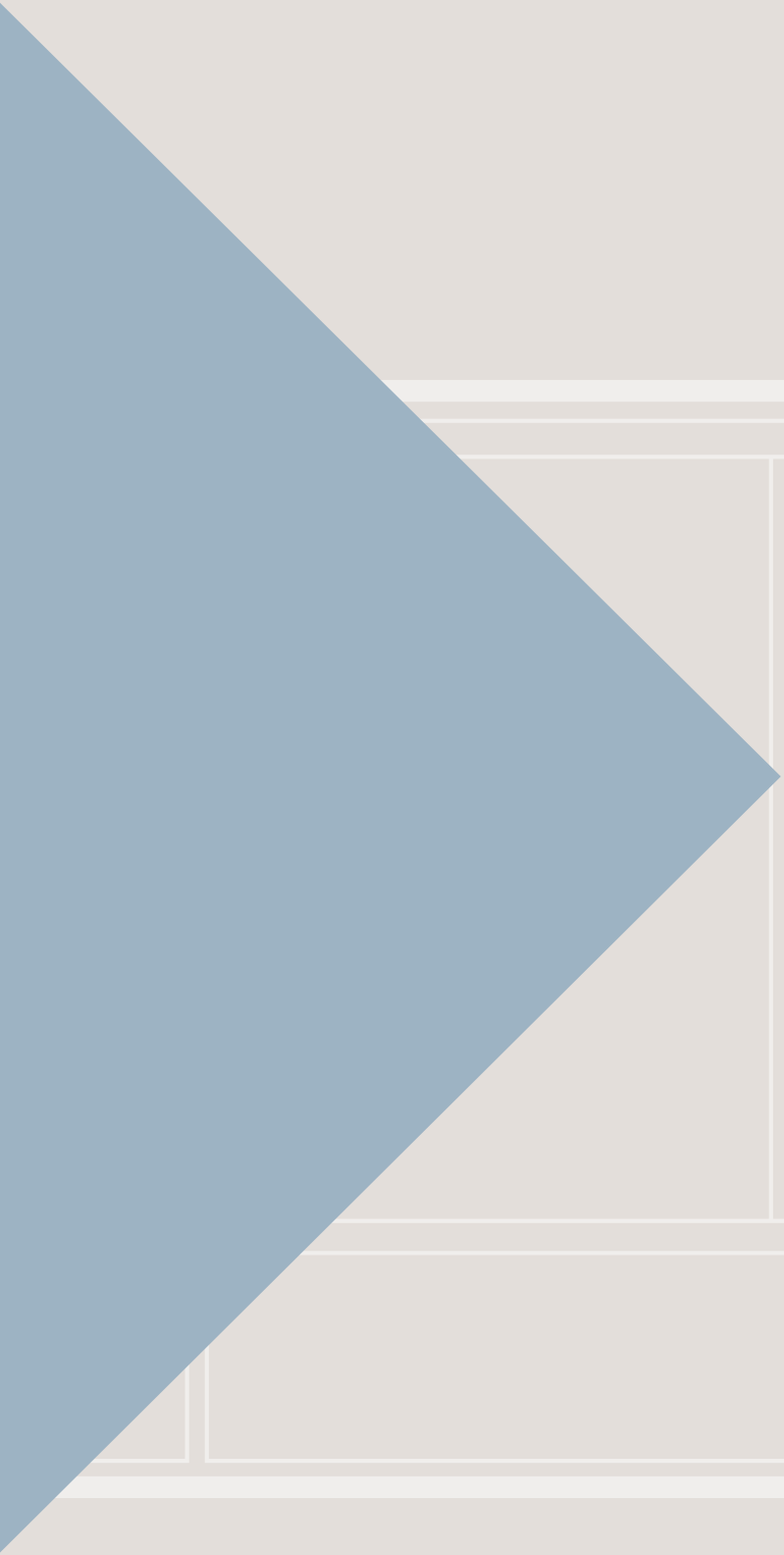

LOCKERWALL

LockerWall by Bisley is the fully integrated, optimum storage and smart locker system that delivers dependable security, without dominating your space or sacrificing your style. Utilising the latest smart locking software, including networked and hard wired locks, personal storage and facility management has never been simpler and safer.

The rise in personal storage requirements is at the forefront of a modern, productive workplace. What was once banished to cloakrooms or basements is now a firmly established part of the front office landscape.

Our personal storage solutions can help free up space, promote productivity and give everyone a sense of belonging.

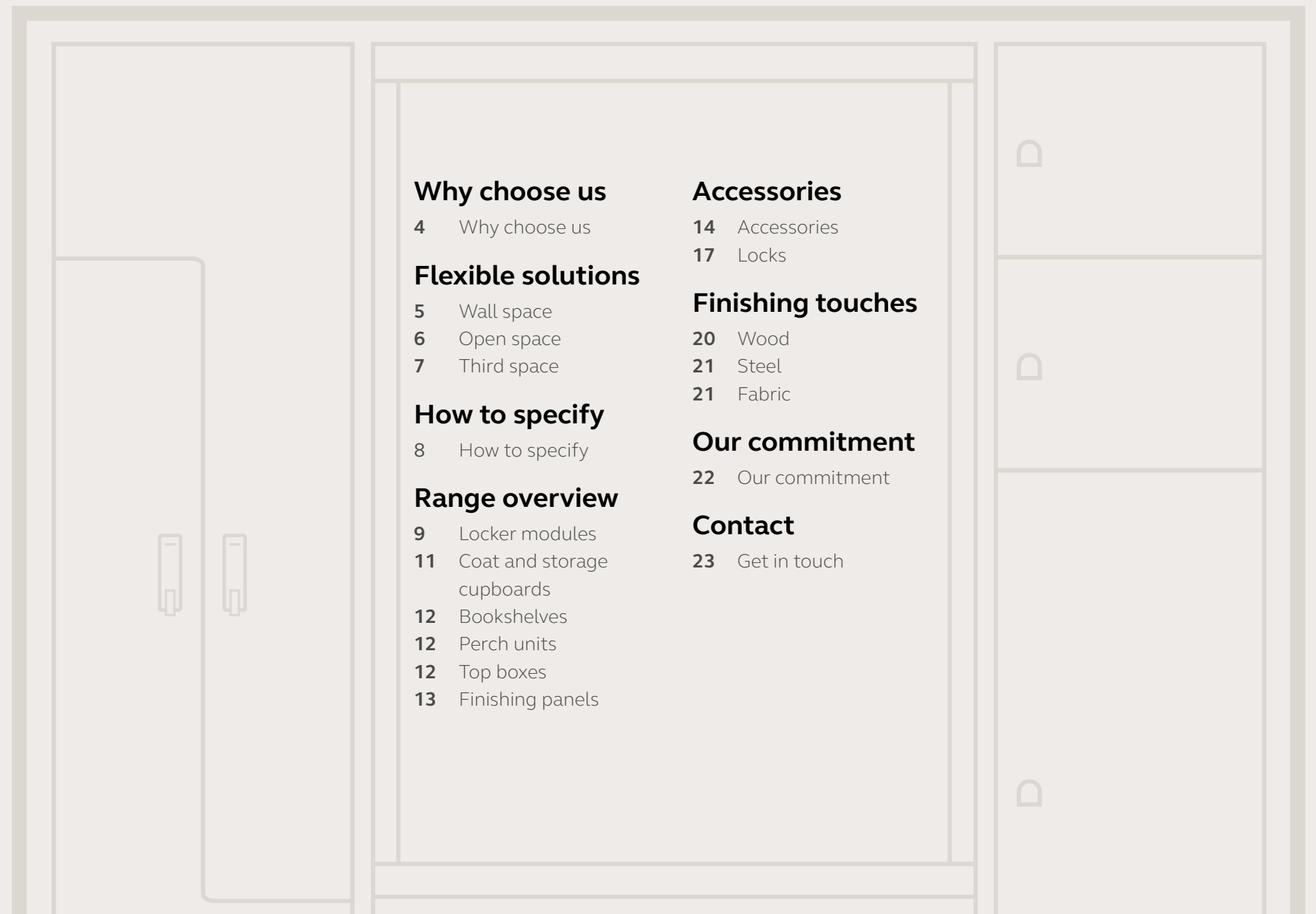

Why choose us

4 Why choose us

Flexible solutions

- 5 Wall space
- 6 Open space
- 7 Third space

How to specify

8 How to specify

Range overview

- 9 Locker modules
- 11 Coat and storage cupboards
- 12 Bookshelves
- 12 Perch units
- 12 Top boxes
- 13 Finishing panels

Accessories

- 14 Accessories
- 17 Locks

Finishing touches

- 20 Wood
- 21 Steel
- 21 Fabric

Our commitment

22 Our commitment

Contact

23 Get in touch



WHY CHOOSE US

Manufacturing excellence that's engineered around you.

We're proud to be a full manufacturer that really is Made in Britain - we manufacture all our own furniture in the UK and export all around the globe - from Wales to the world.

Our lead times are constant. As we are the manufacturer, we are not reliant on third-party suppliers. Continually looking to invest in our factory and practices, we practice Lean Manufacturing techniques, and have invested over £2m in machinery in the last 2 years in our all-new wood plant at our site in South Wales.

We are experts in the production of steel and wood storage. LockerWall combines this with smart lock technology including the latest wired and wireless smart locking solutions for peace of mind.

We can talk you through all the options - from dimensions and accessories, to colours and finishes, or even assist with putting together a precise design specification. Whatever the project size or requirement, we can custom-design and custom-build LockerWall to exactly what you want.

Our expert knowledge is on hand to work for you, helping you get the best from your Lockerwall; we can provide full site surveys, plans and elevation drawings as required. And, we can produce various installation options - whether you need product installation training and site management, or a full delivery and installation service.

Whatever you need, wherever you need it, we'll take care of it.

- Europe's leading manufacturer of steel storage with an on site state-of-the-art wood plant
- Over 80 years of award-winning design expertise
- 15,000 products leave our South Wales factory every week
- Expertise in the latest lock solutions including smart locking software

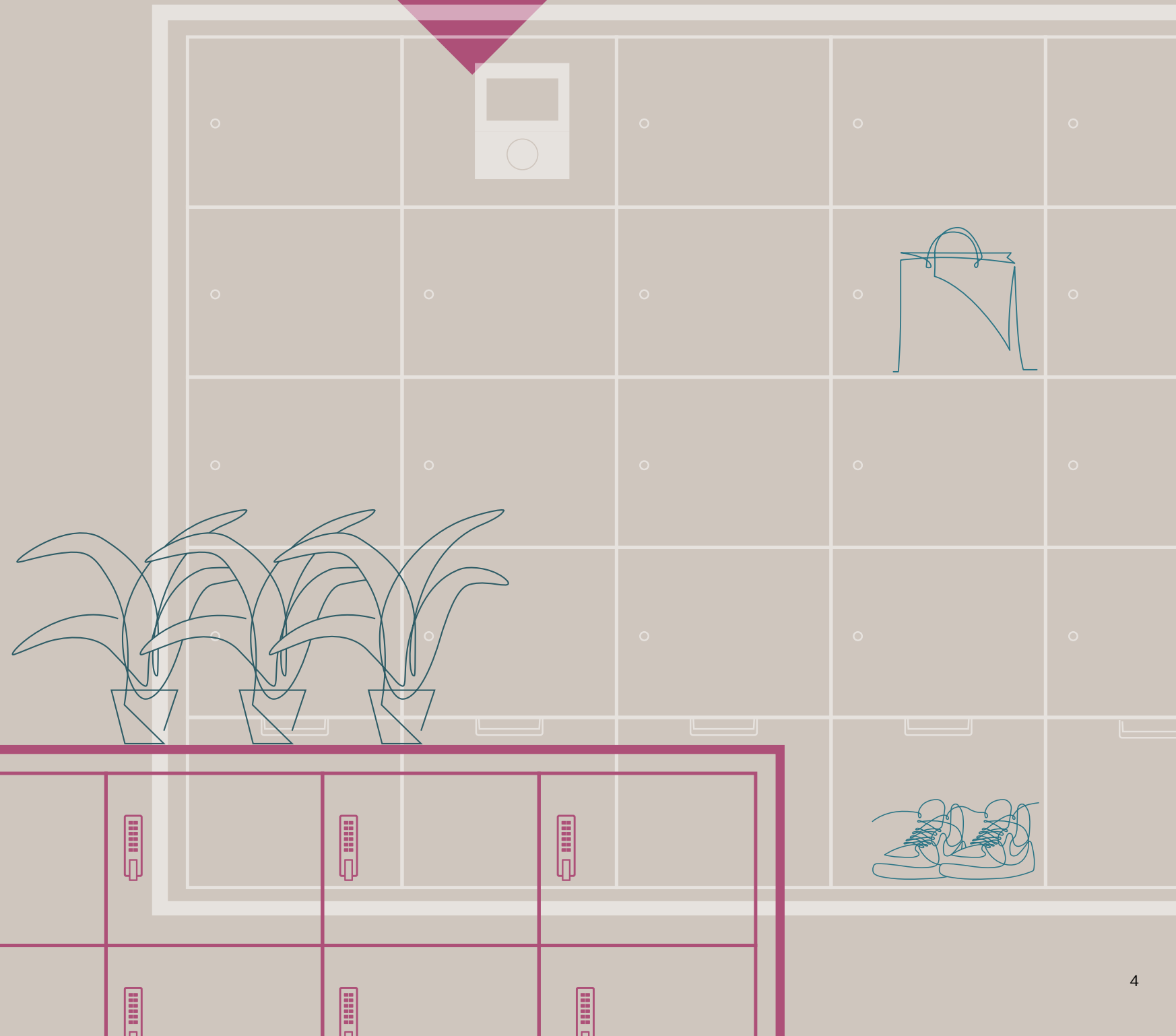

WALL SPACE

A smarter use of your space

Inspired by the traditional locker system, but re-imagined for the contemporary office, LockerWall does what it says on the tin; delivering optimum storage in a sleek, stylish system to suit your organisation's aesthetic. Connect locker and storage modules together to run along empty walls or fill existing alcoves, making the best use of your space and giving colleagues peace of mind whilst at work.



Top

- All locker doors feature the Versa Mini RFID lock
- All doors, drawers, finishing panels and plinths specified in Front White 001 MFC
- End panels specified in Verade Oak 002 MFC

Right

- All doors feature the wireless Digilock Versa keypad lock
- All doors specified in Olive Green BX6 painted steel
- Plinth specified in Soft Black 621 MFC



OPEN SPACE

Storage that works harder

LockerWall is not only a storage system - the lower height lockers can create zoning and space division, giving a workplace defined neighbourhoods. The standing height options double up as an impromptu work surface, or they can be accessorised with planters to bring in mood boosting biophilia.



Below

- All locker doors feature the wireless Digilock Versa RFID lock
- Locker doors specified in Goose Grey AV4
- Top and end panels specified in Natural Kendal Oak 018

Bottom right

- All locker doors are postal slot doors and feature the AB lock
- Steel locker doors specified in Bisley Blue BC6
- All MFC locker doors, finishing panels and plinth specified in Verade Oak 002

Top right

- All locker doors feature the M3 mechanical lock and label holders
- Steel locker doors specified in Palest Pink CB2
- All MFC locker doors, finishing panels and plinth specified in Verona Cherry 019



THIRD SPACE

Designed to fit around you

LockerWall is modular and entirely bespoke, meaning it can flex to create a variety of different workplace settings, outside of the desk. Each column is individual so you can select every unit with your colleagues' needs in mind. Not only is there a huge choice of lockers, but you can mix and match with larger storage cupboards, coat cupboards, bookshelves and soft seating nooks. Whether you want to create a beautiful guest welcome area, dedicated spaces to catch up between meetings or pleasant, functional breakout zones, LockerWall delivers so much more than just storage.



- Top**
- All locker doors feature hardwired Gantner locks with embedded GT7 terminal
 - Coat cupboard features the AB lock
 - All doors, finishing panels and the bookshelf specified in Natural Carini Walnut 645 MFC
 - Plinth specified in Black 574 MFC

- Right**
- All locker doors feature the Versa Mini RFID lock
 - All doors, finishing panels and plinth specified Black 574 MFC

A GUIDE TO SPECIFYING LOCKERWALL

We are here to help



REQUEST A CALLBACK

1 Select your modules

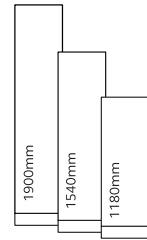

There are 3 heights of LockerWall modules available: 1900mm, 1540mm and 1180mm high.

- Storage cupboards, coat cupboards and bookcase modules are all available in 1900mm high only.
- All locker modules have a choice of **3 lock options** as standard: AB, E4 or M3. Storage cupboards and coat cupboards are fitted with AB locks as standard.
- **Other lock options** including electronic locks are available and our team is on hand to find the best choice for your needs.

All available modules can be found in the range overview.

2 Select your finishing panels

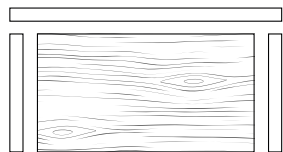

Whether you are designing a freestanding bank of LockerWall or planning to scribe your configuration into an alcove, you will need to select MFC finishing panels.

See our visual guide to finishing panels.

3 Customise your creation

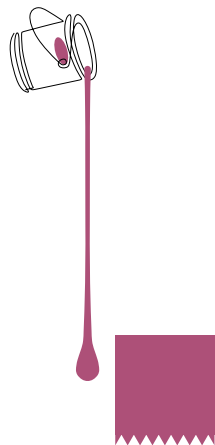

When specifying your LockerWall finishes, there are 4 stages: module doors, carcass, finishing panels and perch pad material (if applicable).

- All carcasses and finishing panels including plinths, fascia panels, top, end and back panels are available in wood (MFC) only.*
- All locker doors are available in either wood (MFC), CGL or the Vision painted steel palette.*
- Z doors are only available in CGL.*
- Coat cupboards and storage cupboards are only available in MFC.*
- If you have included a perch pad, the carcass and fascia panel finish must be specified (MFC only).*
- There are over 50 perch pad fabric colours to choose from.

See our huge range of wood, steel and fabric options.

4 Add accessories and locks

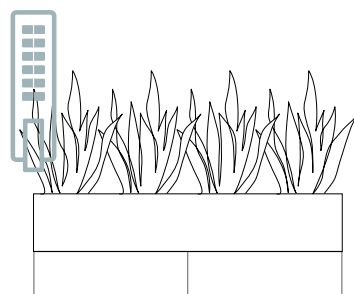

Add additional accessories to your storage to perfectly suit the needs of your workforce. Plus, create peace of mind by specifying the best locking solution.

- Add MFC planter tops to your 1180mm and 1540mm high units.
- Additional internal shelves.
- USB power.
- A4 postal slot trays are available in the Vision painted steel palette.
- Label holders for locker doors.
- Self-adhesive coat hooks.

Thinking about adding a graphic to your LockerWall?

Speak to our team about the options available to create something unique to your brand!

View all accessories and find out more about each lock option.

*Surcharges may apply. Please refer to the LockerWall price list.

LOCKERWALL RANGE OVERVIEW

1180mm high

Locker modules

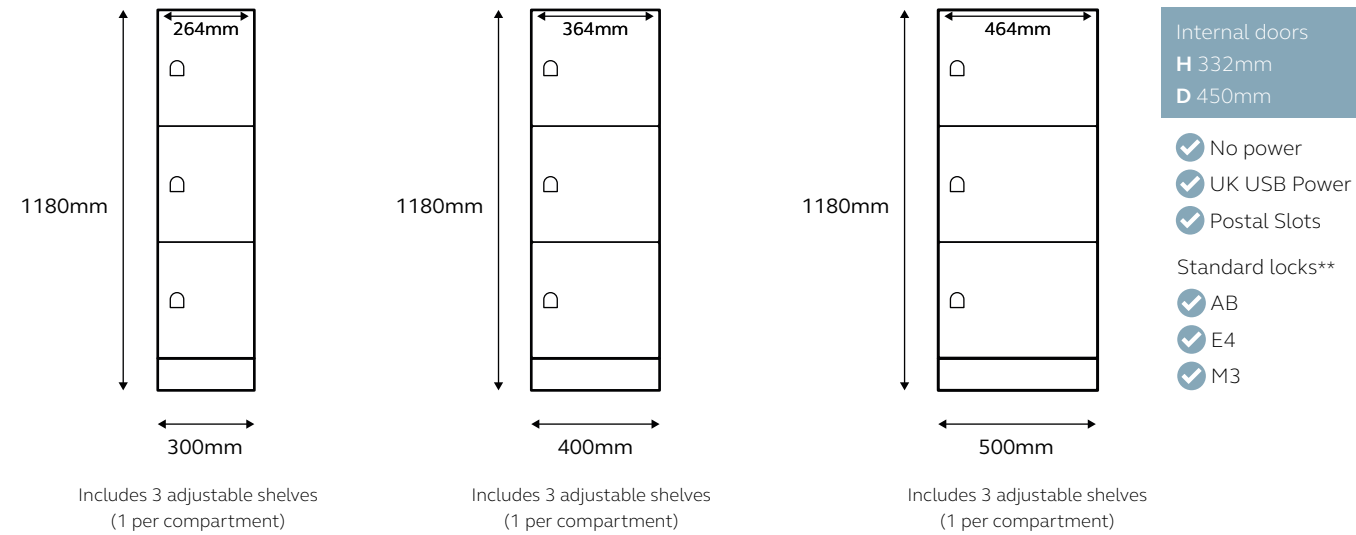

1900mm high

Locker modules

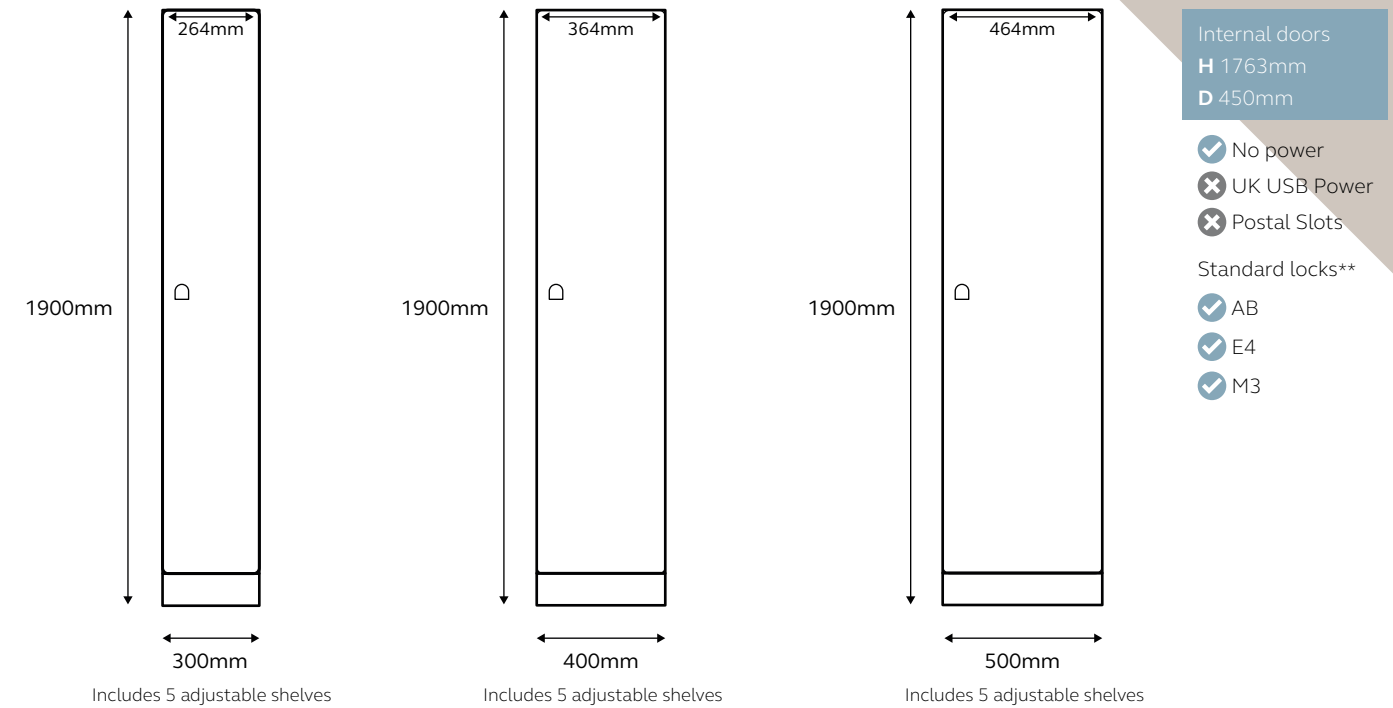

1540mm high

Locker modules

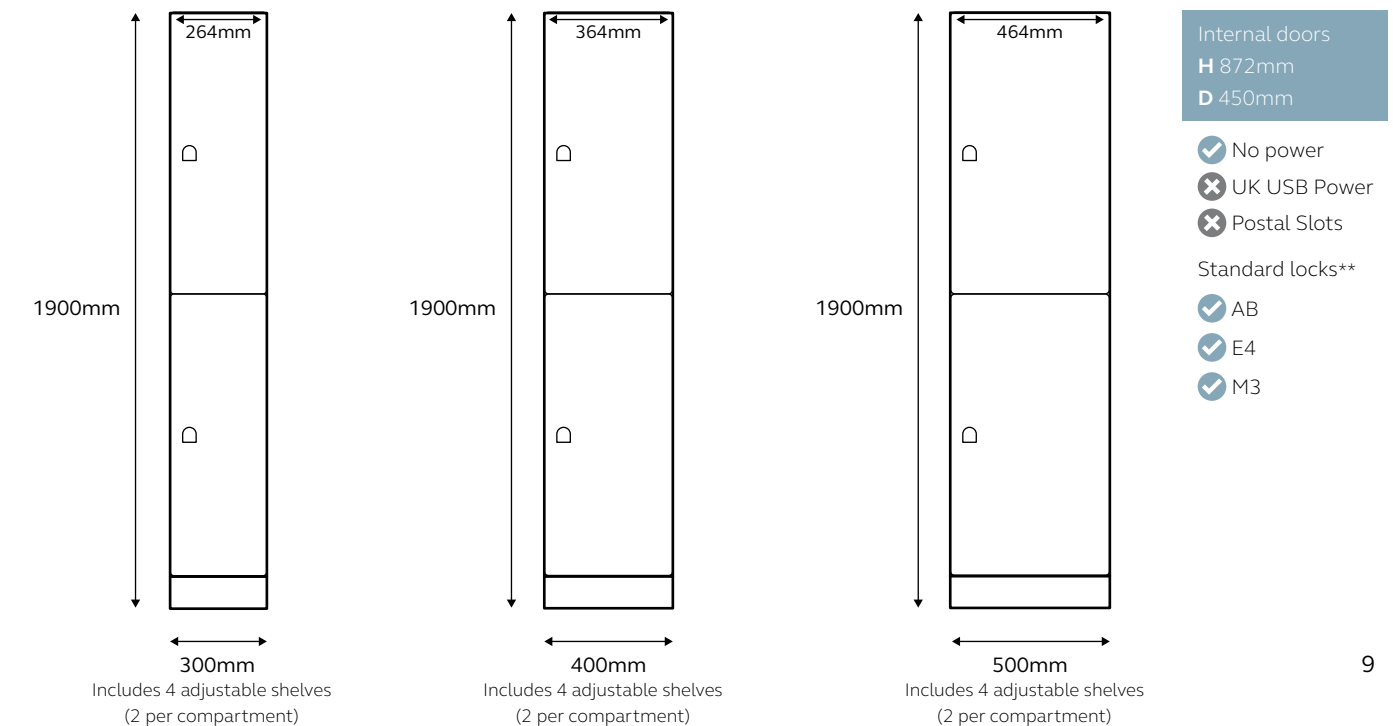
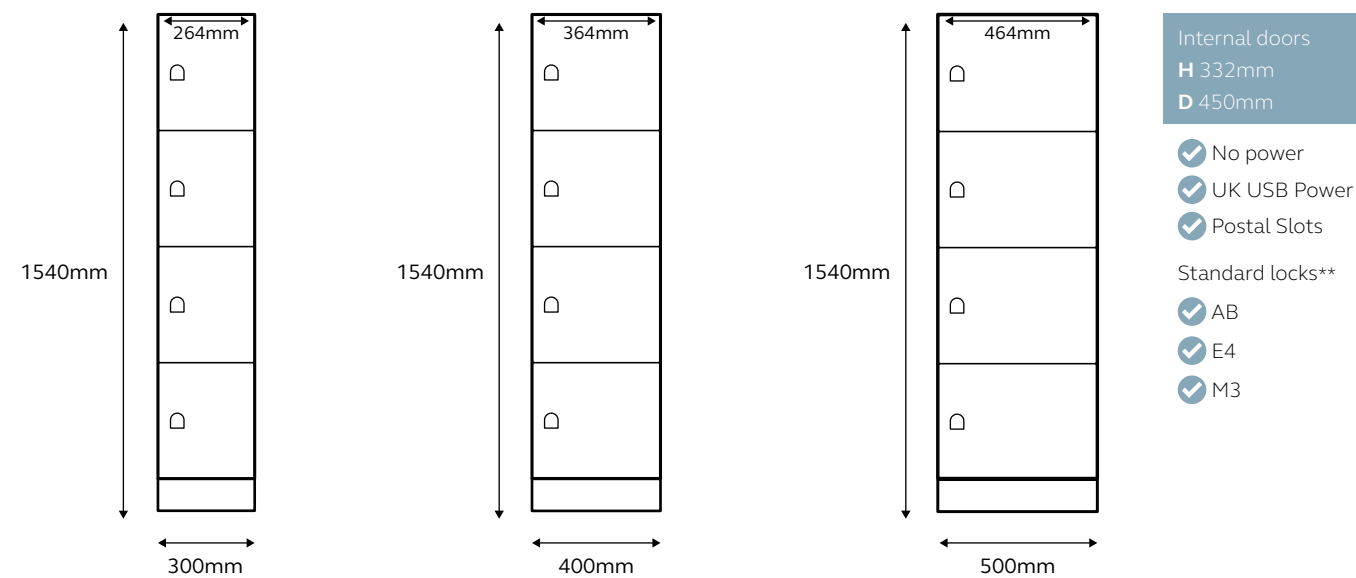

Line drawings are for illustrative purposes only. Please note plinth panels need to be ordered separately. Please see the [finishing panels page](#).

1900mm high

Locker modules

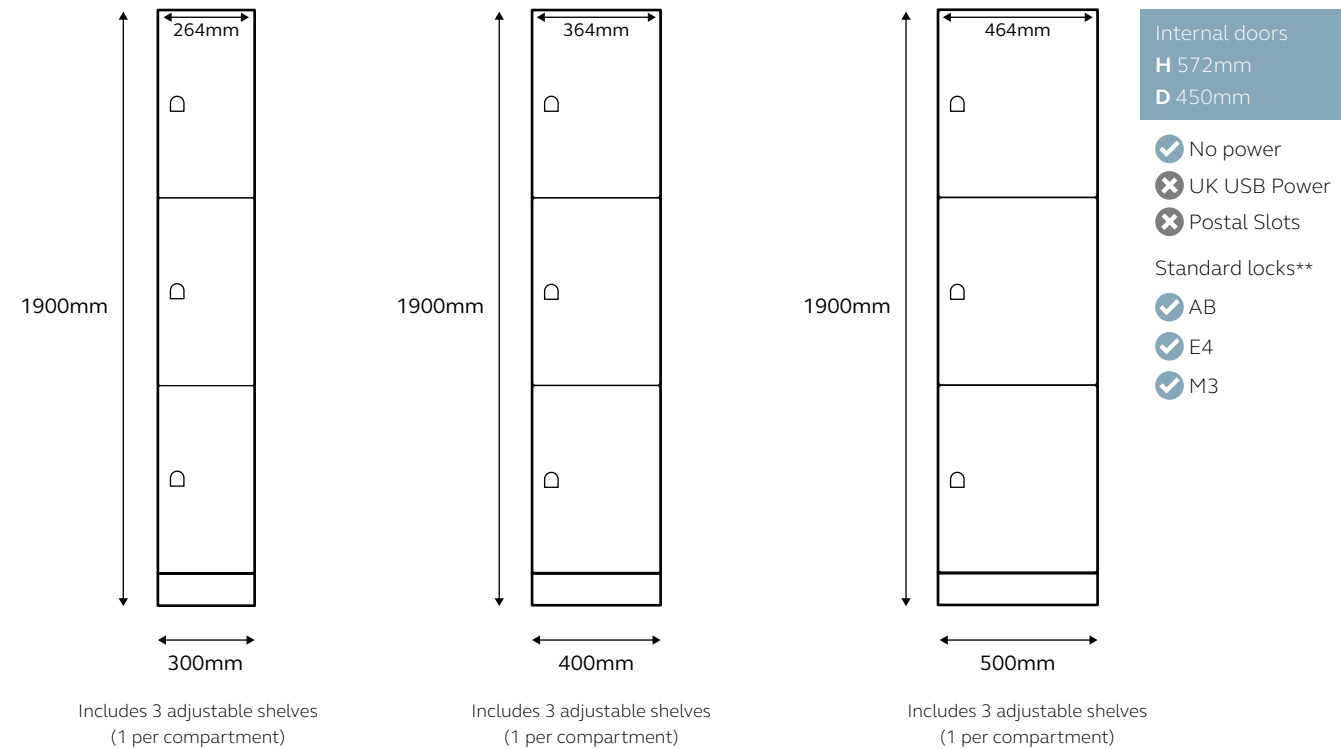

1900mm high

Locker modules

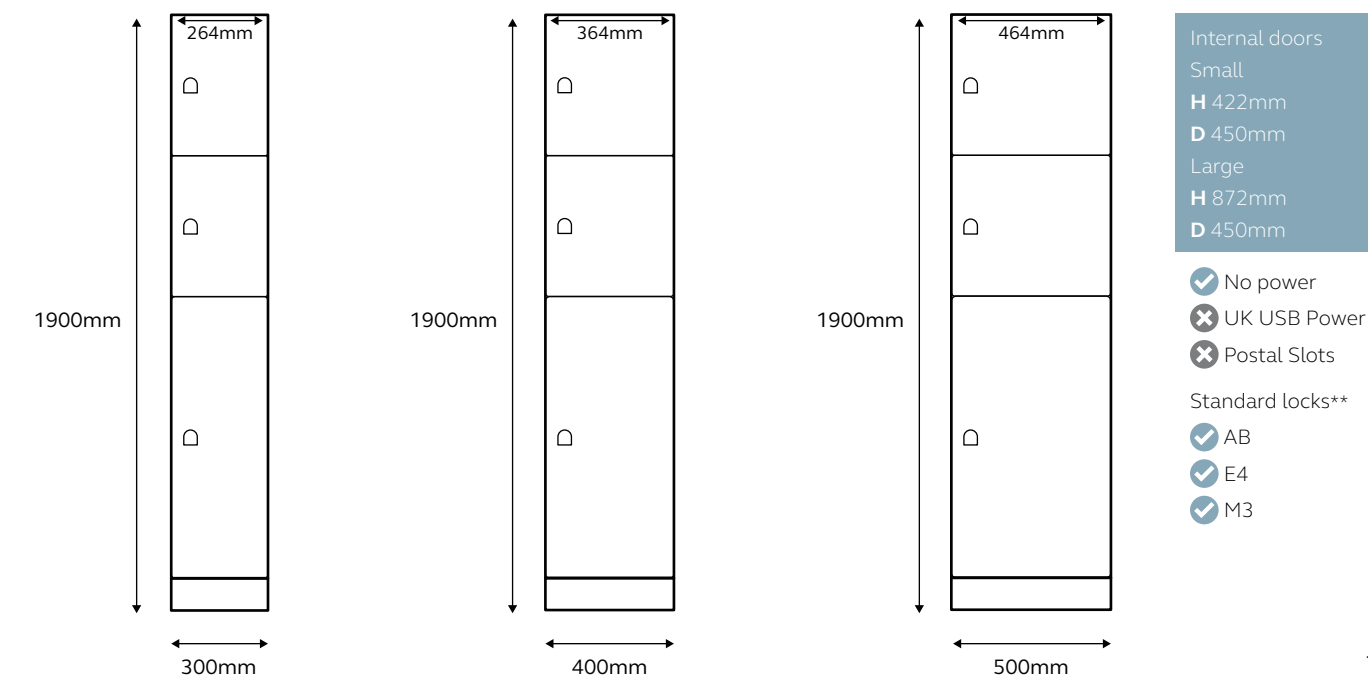
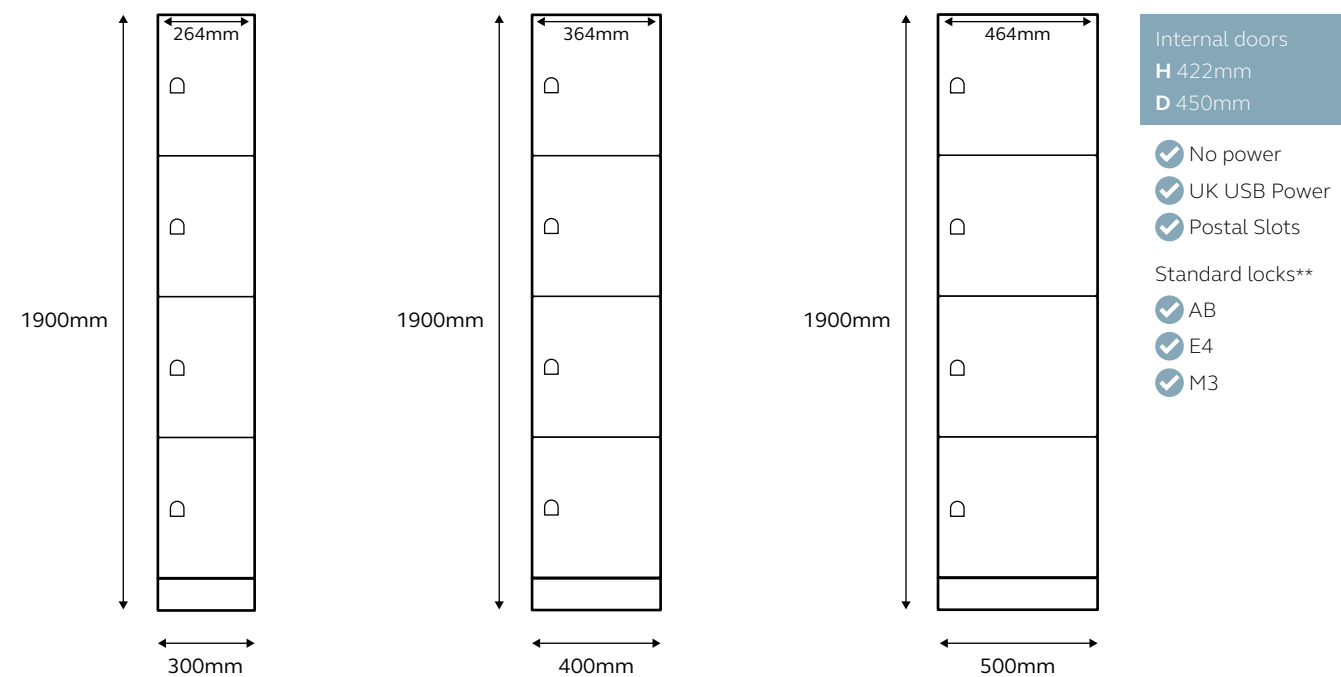
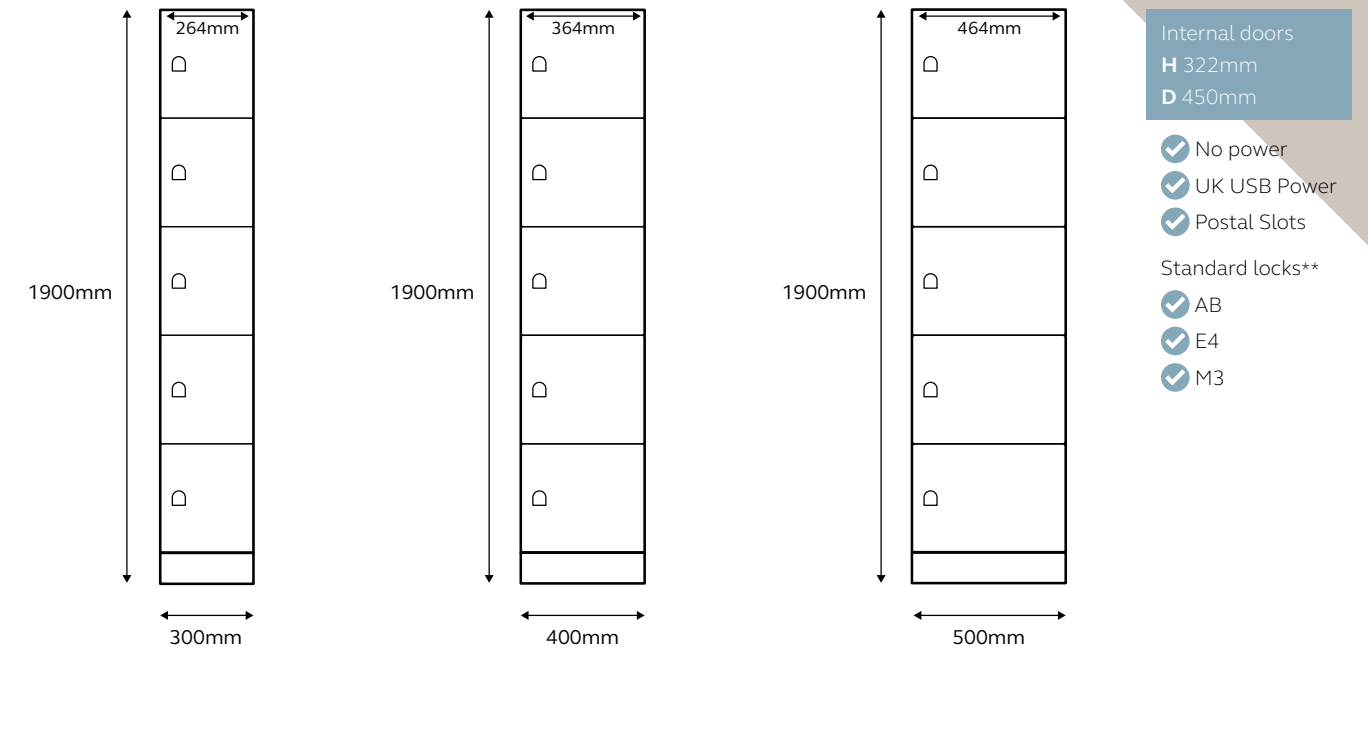

Line drawings are for illustrative purposes only.
Please note plinth panels need to be ordered separately. Please see the [finishing panels page](#).

1900mm high

Locker modules

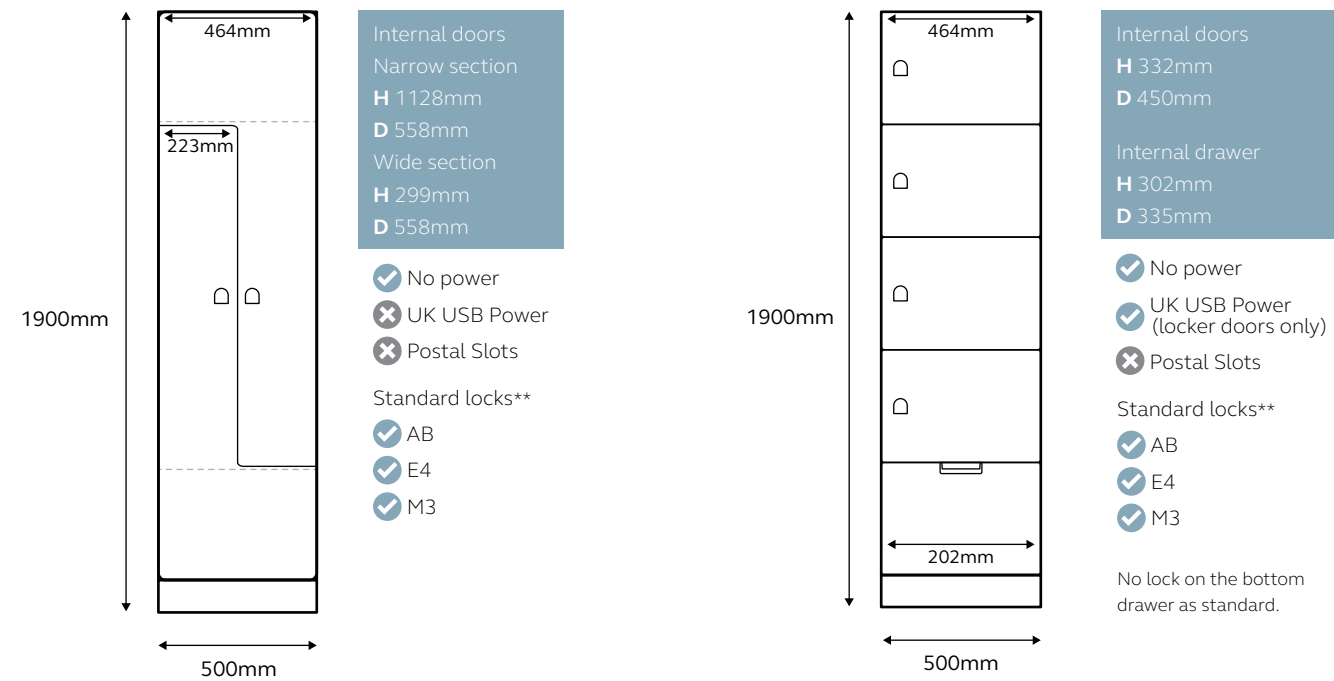

1900mm high

Coat cupboards

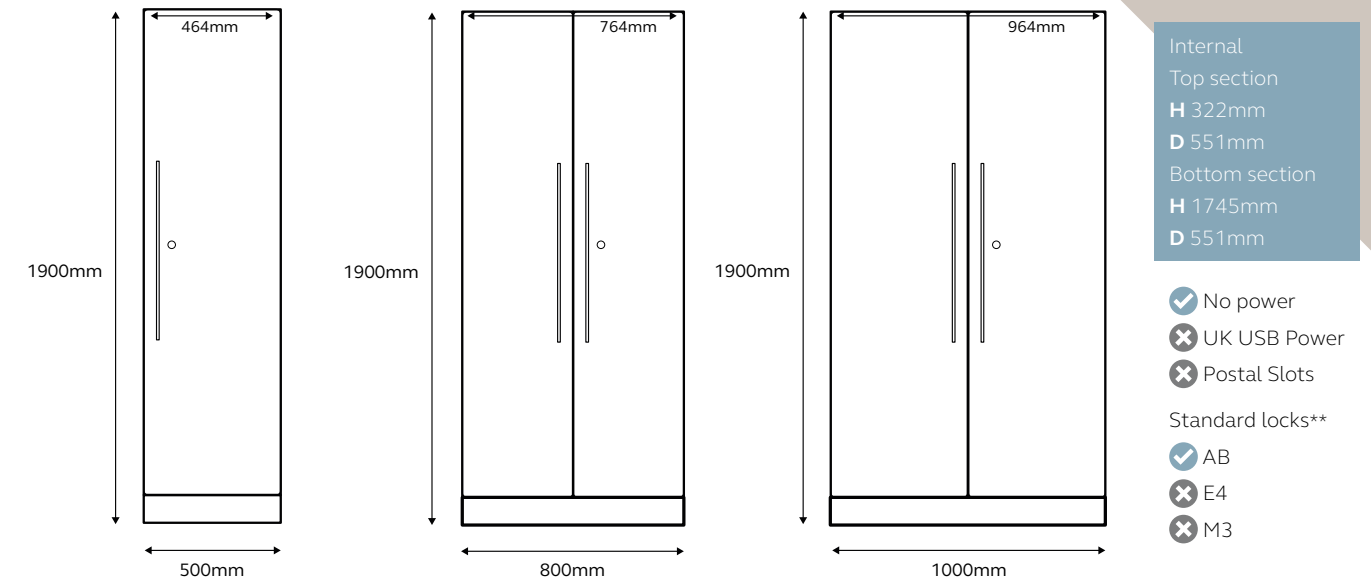

Storage cupboards

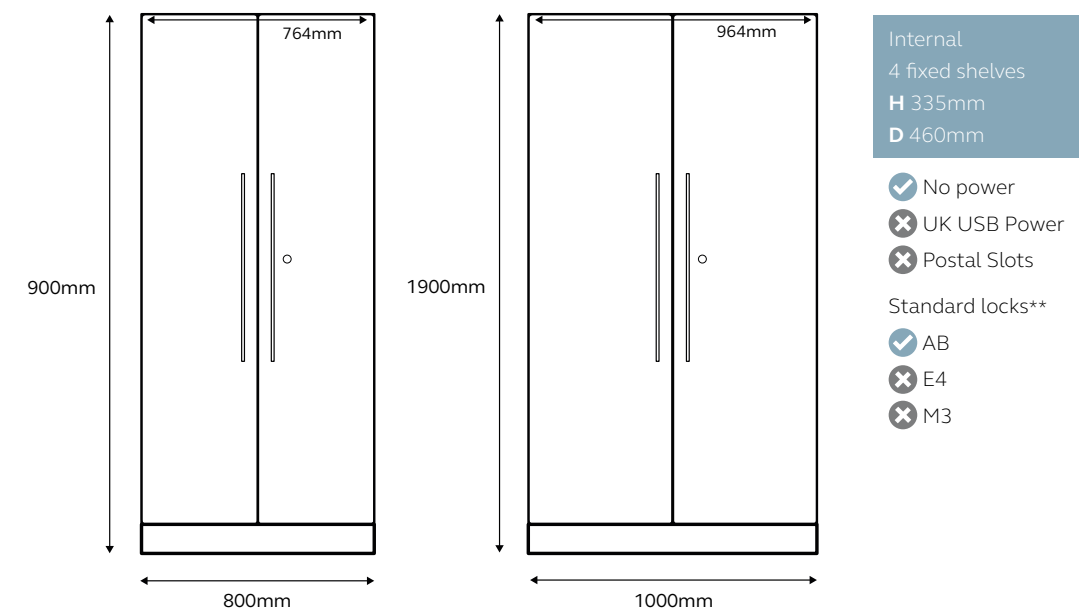

1900mm high

Bookshelves

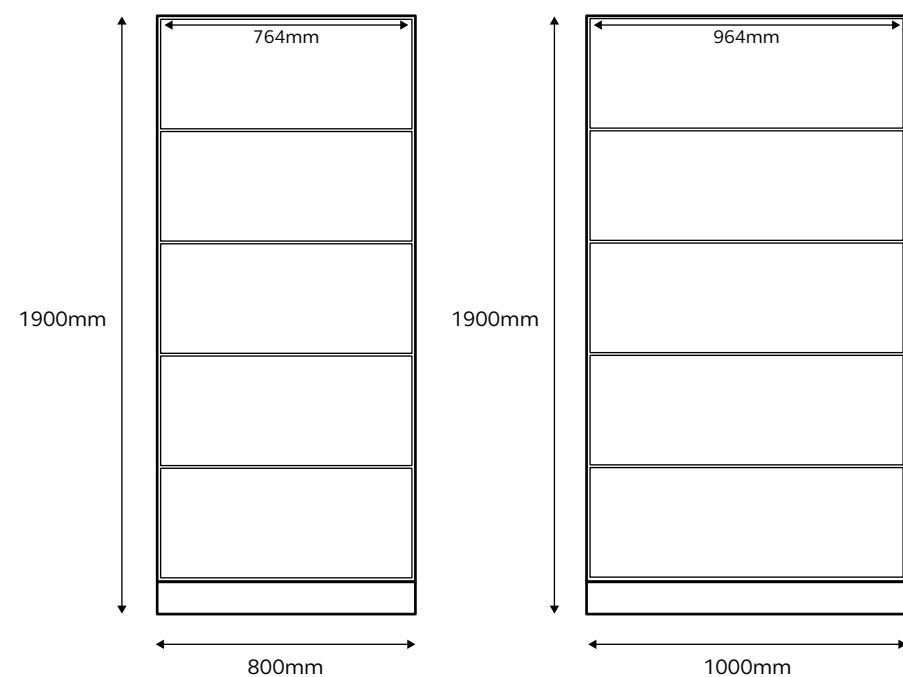

Internal shelves
4 fixed shelves
H 335mm
D 460mm

- No power
- UK USB Power
- Postal Slots
- No locks

Topboxes for 1900mm high modules

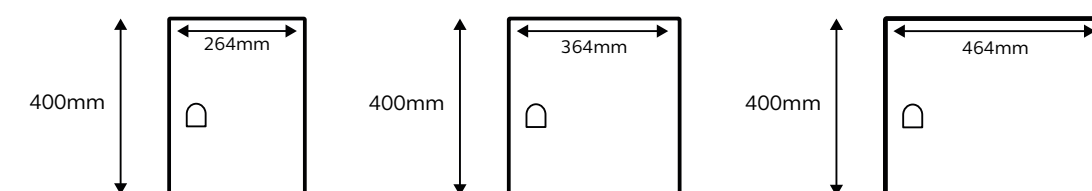

Internal doors
H 363mm
D 450mm

- No power
- UK USB Power
- Postal Slots

Standard locks**

- AB
- E4
- M3

Perch units

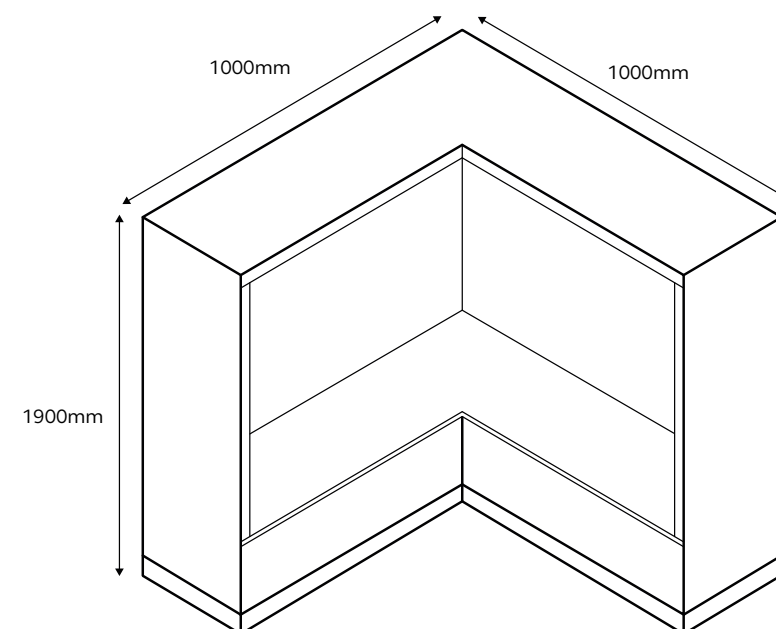
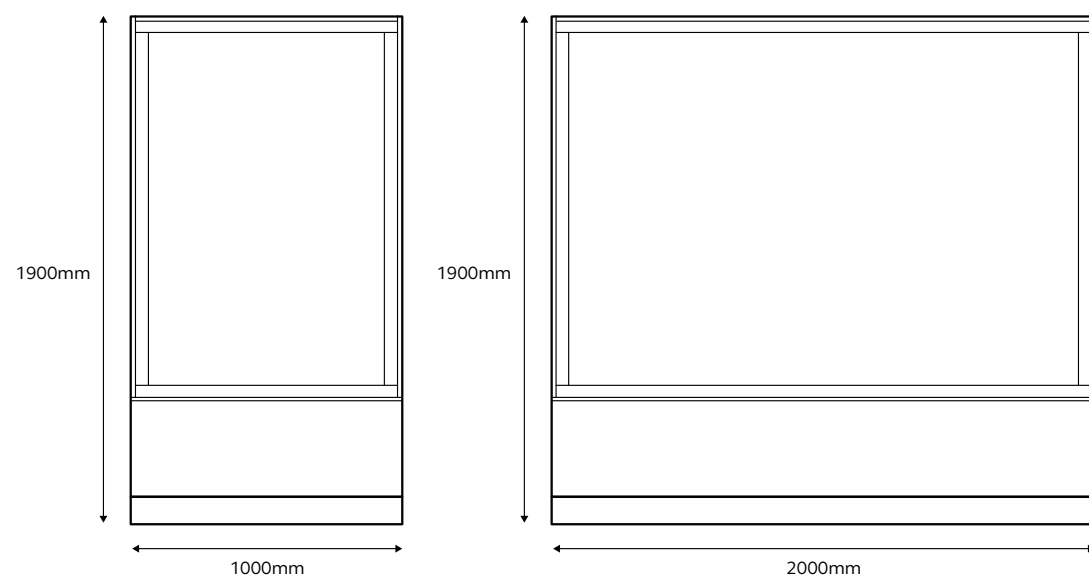

- No power
- UK USB Power
- Postal Slots
- No Locks

FINISHING PANELS

Whether you are designing a freestanding bank of LockerWall or planning to scribe your configuration into an alcove, you will need to select a variety of MFC finishing panels.

This guide illustrates the panels needed for each LockerWall setting e.g. freestanding, against a wall or scribed in to an alcove.

Please contact your Bisley Representative for all finishing panel sizes.

Freestanding



You will need to specify:

- ① Top panel(s)
- ② Left and right hand end panels
- ③ Back panel
- ④ Plinth(s)

Against a wall

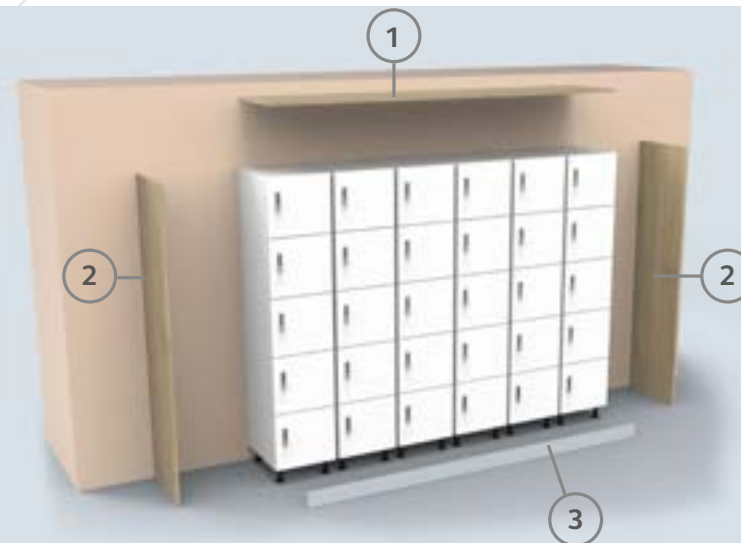

You will need to specify:

- ① Top panel(s)
- ② Left and right hand end panels
- ③ Plinth(s)

Fully scribed in (alcove or wall space)

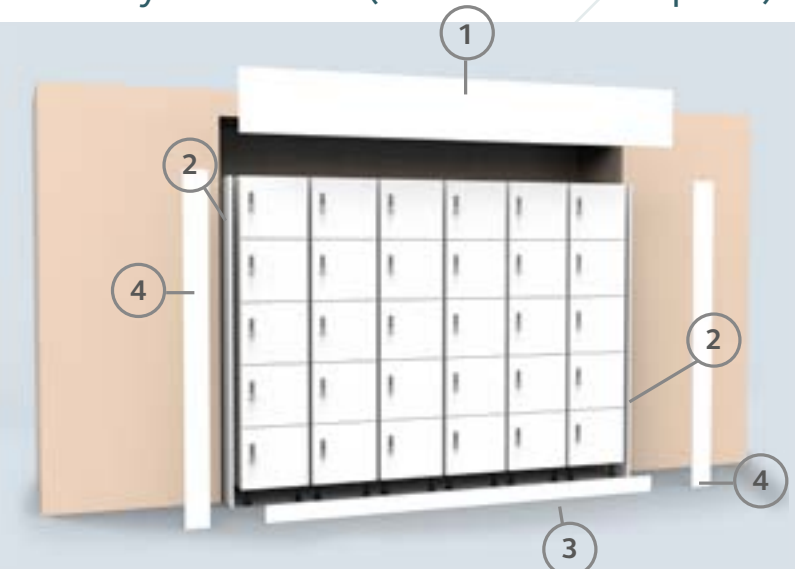

You will need to specify:

- ① Top fascia panel(s)
- ② Left and right hand end panels
- ③ Plinth(s)
- ④ Infill panel(s) if required

Please note

All additional panels (plinth, infill panels, top fascia panels and end panels) are available in MFC only.

ACCESSORIES

LockerWall helps you reinvent how your office looks, works and flows. And once you've specified your bespoke configuration, you can accessorise with all the essential amenities to provide your workforce with everything they need to be comfortable, organised and productive whilst at work.

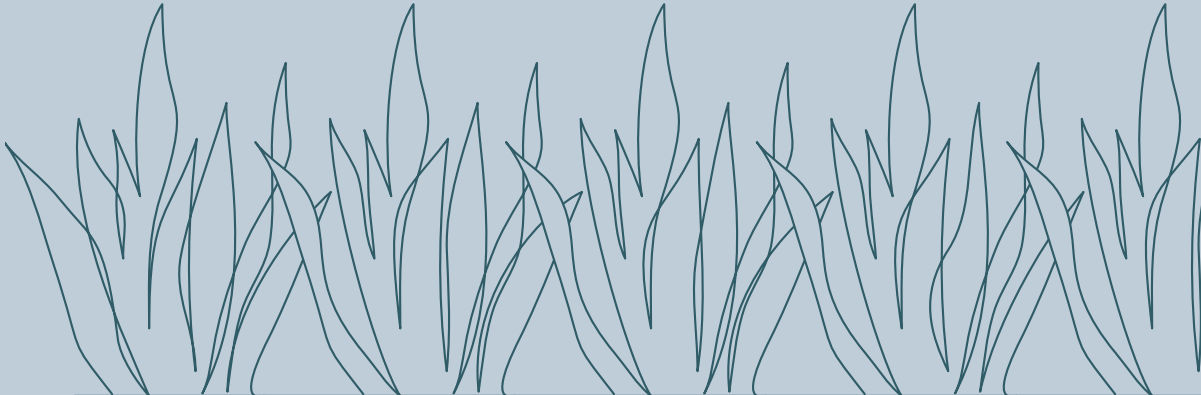

Planter boxes for 1180mm and 1540mm high modules

800mm wide planter box

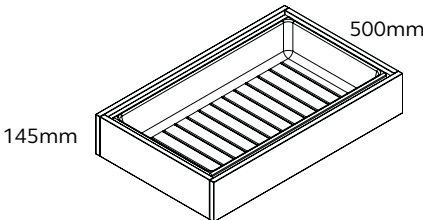

1000mm wide planter box

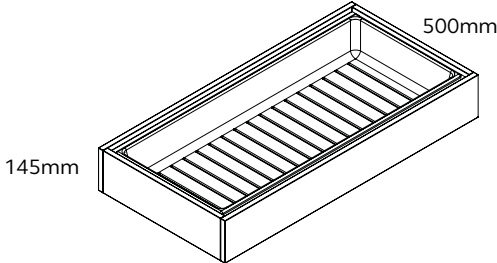

A4 steel postal slot tray*

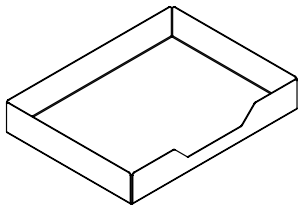

Additional locker internal shelves

300mm wide locker shelf

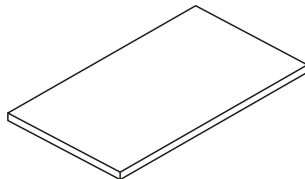

400mm wide locker shelf

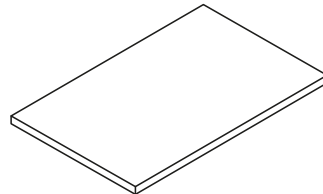

500mm wide locker shelf

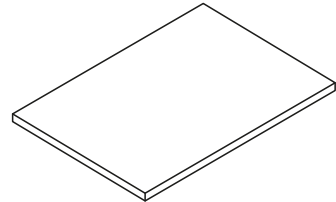

USB power within lockers*

Self adhesive coat hook

Label Holder

*Please refer to the [range overview](#) to find out which modules are compatible. Please note that USB power cannot be retrofitted.

ACCESSORIES



- 1** Self-adhesive coat hook
Mount these additional hooks anywhere in your LockerWall for handy extra organisation.
- 2** Additional adjustable internal shelves
Add extra storage compartments within each locker. There are three sizes available to fit all three locker widths.
- 3** A4 steel postal slot tray
Available in 33 colours from the steel paint Vision palette. Please refer to the **range overview** to find out which modules are compatible.

- 4** Label holders
Easy application and ideal for lockers with assigned users.
- 5** USB power within lockers
Users can charge their technology whilst it's securely locked away. Please refer to the **range overview** to find out which modules are compatible. USB power cannot be retrofitted.
- 6** MFC Planter Box
Bring the outside in and create uplifting biophilia displays by adding MFC planter boxes to the lower height 1180mm and 1540mm high modules. Available in the full range of **MFC finishes** to match your chosen doors and finishing panels.



LOCKS

We design and manufacture the highest quality personal storage lockers, but we also have the knowledge and expertise on hand to advise you on the best lock choice.

Our wide range of secure locking options for LockerWall gives all employees – whether permanent, mobile or nomadic – a sense of control, peace of mind and belonging whilst in the office.

There are a variety of solutions to choose from. Wireless and hard-wired smart locks are compatible with the latest remote access technology, putting you in complete control. Or, more traditional key and combination locks are a great solution for visitors and shared storage spaces.



Speak to us about your locking requirements and we can recommend a solution to best suit your needs.

Smart Locking Solutions



Wireless Smart Locks

Wirelessly connected for efficiency and seamless worldwide integration, the latest smart locking technology, Digilink, allows management to remotely assign and manage users, access audit and analytics reports, schedule auto lock/ unlock and receive instant alarm alerts.

Working hand-in-hand with attractive RFID or keypad operated locks, these locks are recommended for our premium storage ranges, including LockerWall, for optimum security.

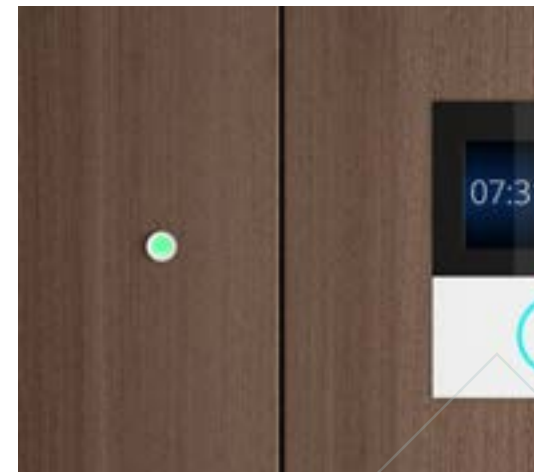

Hard-wired Smart Locks

Hard-wired smart locks are sleek in appearance and offer convenient benefits with the management hardware and app packages available. The terminal can be fitted to a surface (e.g. mounted to a wall) or embedded directly into a bank of lockers, streamlining locker management by operating with new credentials or even pre-existing staff-ID cards. The management software offers a real time audit trail, utilization reports and the possibility to assign lockers from mobile devices.

LOCKS



Versa Mini Basic (RFID Lock)

A smart, swipe operated RFID lock option with a range of user accessories available including cards, wristbands and keyfobs.

IP55 rated, these locks are suitable for humid conditions, include visual and audible indicators and can be set to shared or assigned use. Upgrade to the advanced Versa Mini lock which is compatible with a mobile app so management can easily manage users and power.



M3 Mechanical Locks (Assigned use)

The M3 Mechanical Lock is ideal for a single user, with secure four-digit codes, integrated scramble feature and a master key for management override.



Versa Mini Basic (E4 Digital Lock)

Suitable for shared and assigned use, this lock features secure four to seven digit codes and both visible and audible indicators. The advanced version of this lock, available as an optional upgrade, is also compatible with a mobile app to manage power and user credentials, amongst other remote features.



M2 Mechanical Locks (Shared use)

All the benefits of the M3 Mechanical Lock, but more suited to public use with new user codes easily set up each time the lock is open.



AB Lock

AB locks are a great, cost effective option if you are looking for a straightforward, secure solution with user keys, ideal for both assigned and shared lockers.



Speak to us about your locking requirements and we can recommend a solution to best suit your needs.

FINISHING TOUCHES

LockerWall gives you the scope to create an efficient, stylish storage system for any kind of environment. It can be customised to fit entirely with you and your aesthetic. And with the vast range of materials and finishes, including premium wood and CGL palettes and steel paints, LockerWall is entirely bespoke, allowing you to design a sleek system that suits your space.

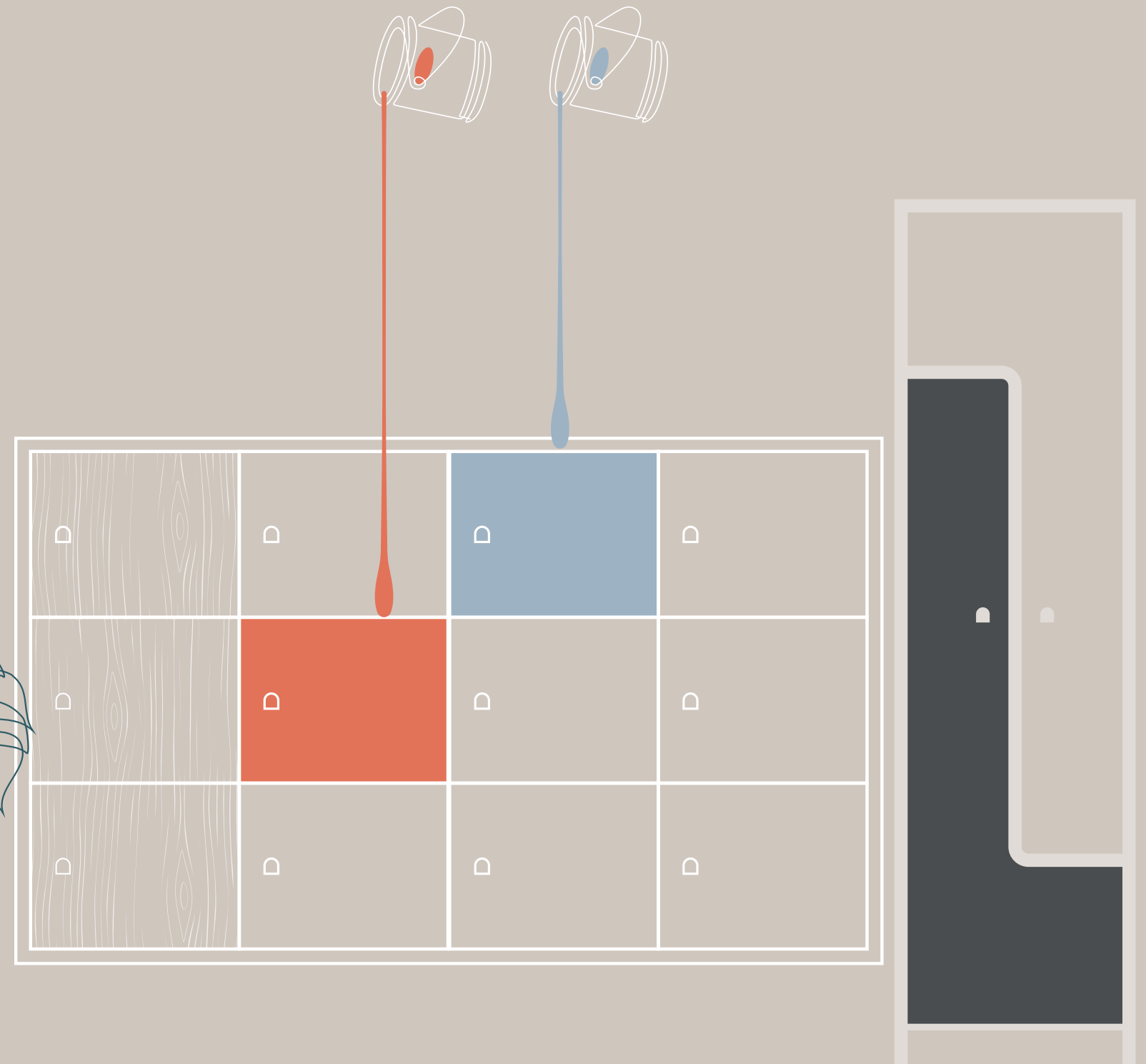

FINISHES

MFC finishes

Primary



Classic

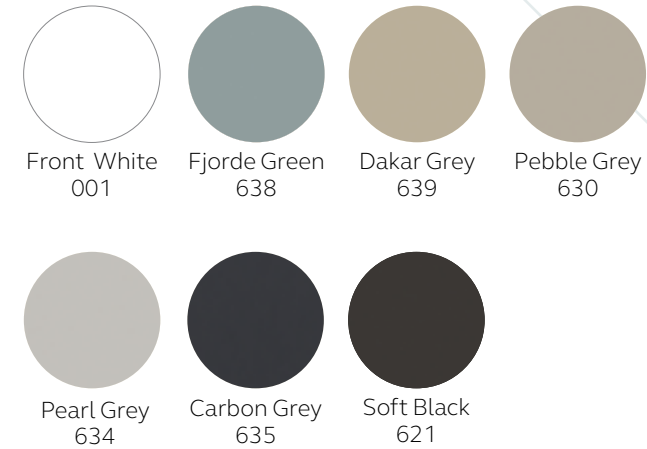

CGL finishes (Compact Grade Laminate)

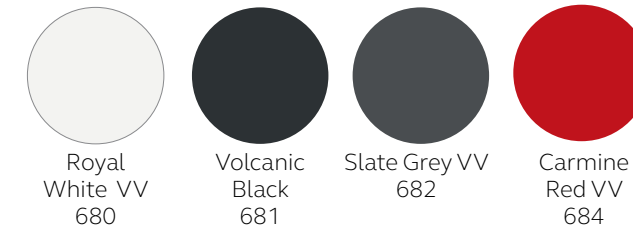

Compact Grade Laminate is a hardwearing, durable material with excellent resistance to scratches and general wear and tear. It is ideal for high traffic areas and wet room environments.

Vision

(Surcharges apply)

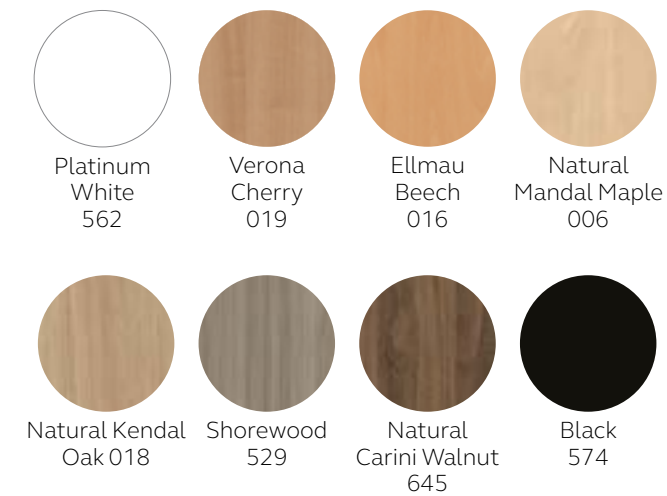

Performance

(Surcharges apply)

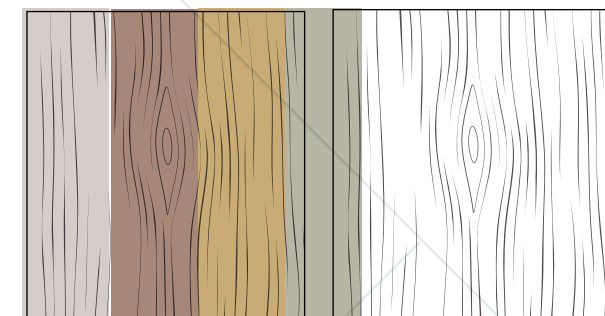
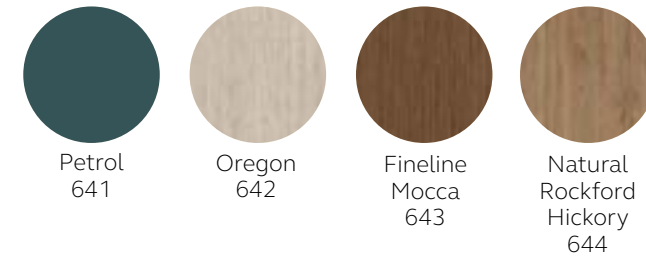

FINISHES

Steel paint finishes

Vision 

						
Black AV1	Anthracite Grey AA3	Slate AN9	Doulton AN7	Azure BP5	Bisley Blue BC6	Silver ARN
						
Prussian BP7	Oxford Blue AY7	Ocean Blue BZ2	Olive Green BX6	Bisley Green BH2	Regent AG8	Goose Grey AV4
						
Sepia Brown BR8	Coffee AV5	Dijon BQ5	Tickleweed BQ6	Cream AV6	Light Grey AV7	York AG9
						
Seville BQ4	Cardinal Red AY8	Bisley Orange BN6	Golden Sunflower CD1	Yellow BP2	Beige AV8	Portland AB8
						
Fuchsia BE2	Bisley Pink BR4	Palest Pink CB2	Chalk AB9	Traffic White BA5		

Fabric finishes

				
Dartmouth	Fairfield	Stanford	Eynesbury	Woodcroft
				
Latymer	Sheffield	Bryanston	Tyndale	Montcrest
				
Knightsbridge	Oxford	Barnard	Abertay	Glasgow
				
Marymount	Silcoates	Goldsmith	Silverdale	Napier

There are over 50 Camira Blazer fabrics to choose from for the perch pad. We have selected 20 that best match some of our most popular paint colours as a helpful guide. Please contact your Bisley Representative for information on the full Camira Blazer range.

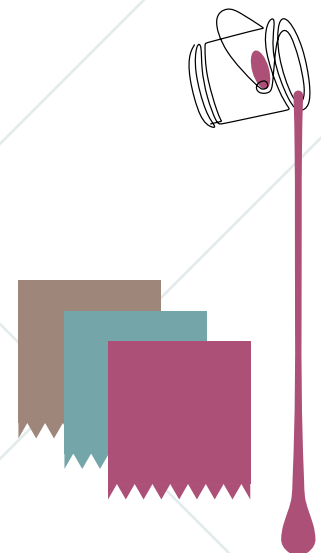

Black, Light Grey and Traffic White are also available in **Biocote**, which is an anti-microbial paint that works actively against microbes with the aim to prevent them appearing by up to 99.99%. Other colours available on request. Please note there is a surcharge for these finishes.

OUR COMMITMENT

Better for you, better for the environment

As a proud British manufacturer, we take our responsibilities towards the environment very seriously, ensuring that sustainability runs through everything we do. Our dedicated Sustainability team ensures that our facilities are as sustainable as possible, while making sure that our products last and are sustainably sourced.

Bisley products are designed for functionality, durability, and a long service life. They are all tested rigorously to British and European harmonised standards for safety, strength and stability. We have also invested in the undertaking of Life Cycle Analyses (LCA) for much of our steel product portfolio, to fully understand their environmental impacts in terms of global warming, acidification, eutrophication, ozone depletion and other indicators across all phases of a product's life cycle - from cradle-to-grave. Our wood products are also FSC™ certified which supports responsible forestry management.

As for energy, we source all of the energy that powers our manufacturing activities through renewable energy tariff and we also participate in the Energy Savings Opportunity Scheme (ESOS), which has led to substantial investment in procurement and installation of energy efficient machinery and equipment.

But, we can always be doing more, and the team is constantly reviewing how we do things and how we might improve.

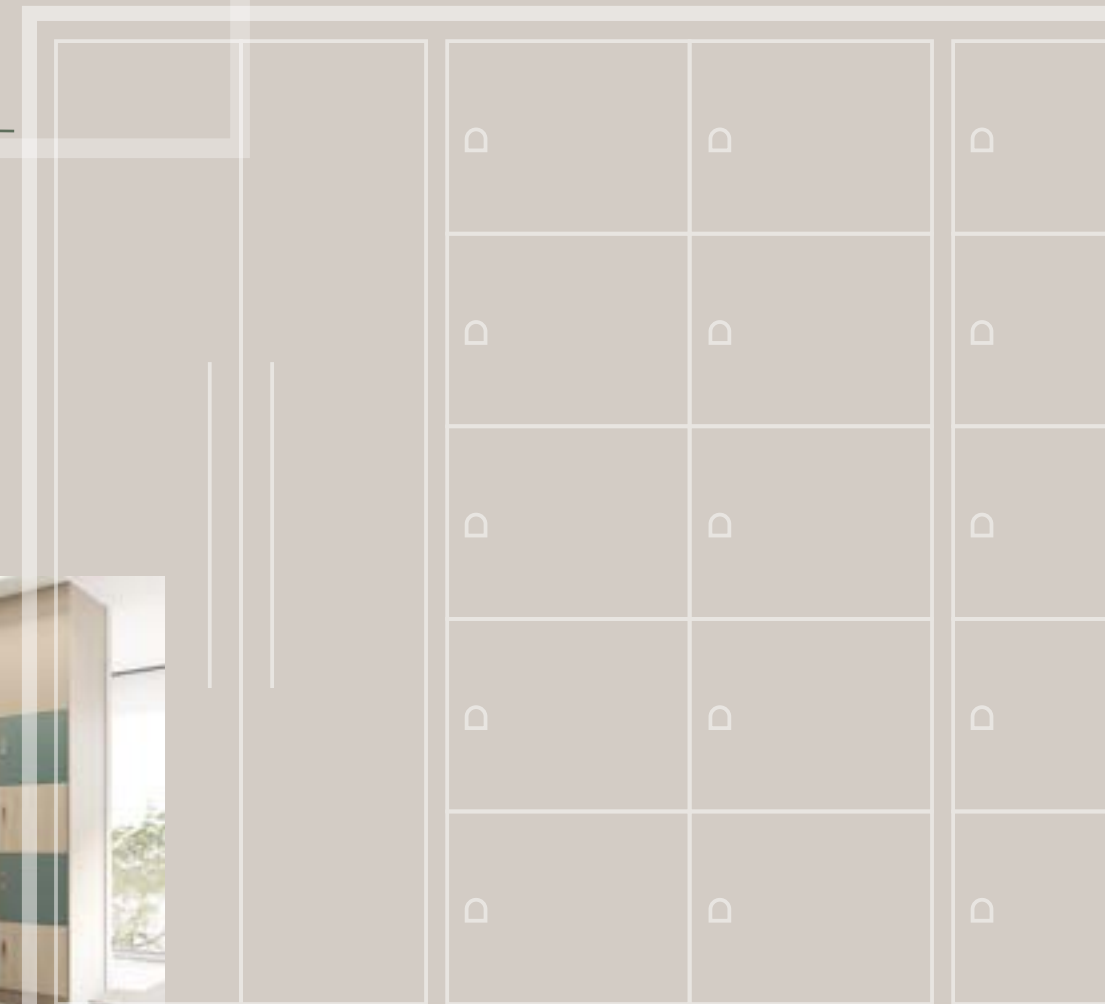

Visit [bisley.com](https://www.bisley.com) to find out more, or contact your Bisley Representative for more information on the LockerWall range.

Get in touch
www.bisley.com/get-in-touch

 @wearebisley

 @wearebisley

 Bisley Storage

